

# 190971G Coil and Shutter Assembly Replacement

## INSTALLATION INSTRUCTIONS

### APPLICATION

The 190971G Coil and Shutter Assembly is used in the C7024 and C7961 dynamic self-check UV flame detectors. The shutter assembly covers the UV sensing tube, as directed by its amplifier, to determine sensing tube proper operation.

### FEATURES

- High-density shutter pad
- Provides indication of proper sensor operation

### INSTALLATION

#### C7024 Flame Detector Coil and Shutter Replacement

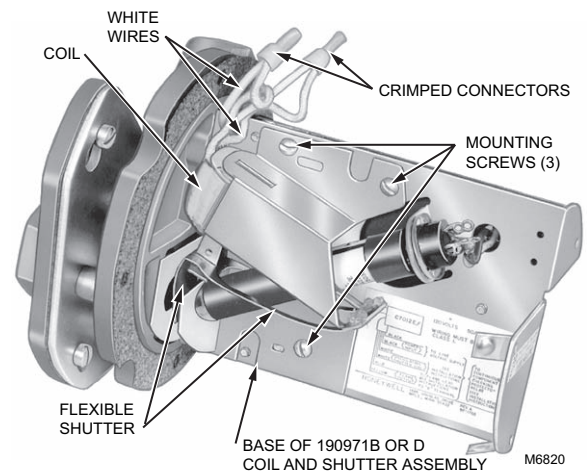

**Fig. 1. Replacing coil and shutter assembly on C7024E,F.**

1. Open the master switch and remove the detector cover. Keep screws or bolts in a safe place.
2. Remove the ultraviolet sensing tube.
3. Cut the white wires as close as possible to the crimped connector and remove the crimped connectors.
4. Remove the three mounting screws from the base of the coil and shutter assembly. Put the screws in a safe place to avoid losing them.
5. Remove the coil and shutter assembly.
6. Put the new coil and shutter assembly into place.

#### **IMPORTANT**

*Be very careful not to kink or otherwise damage the flexible shutter.*



7. Insert the three mounting screws into the base of the coil and shutter assembly and securely tighten.
8. Remove sufficient insulation from each of the two white leadwires remaining on the detector, and also from each of the two white leadwires on the new coil.
9. Using solderless connectors, connect one of the coil wires to one of the remaining white leadwires. Connect the other coil wire to the other remaining white leadwire.
10. Reinstall the sensing tube.

NOTE: The C7024F cover has a small hole that is keyed to a pin on the body flange.

## C7961 Flame Detector Coil and Shutter Replacement

You must remove the old shutter assembly before installing the replacement assembly. To remove the shutter assembly:

1. Open the Master Switch. Remove the flame detector cover by removing the 4 captive cover screws and carefully slide off the cover. Keep screws in a safe place.
2. Remove the paired set of screws on one side of the circuit board, as shown in Fig. 2.

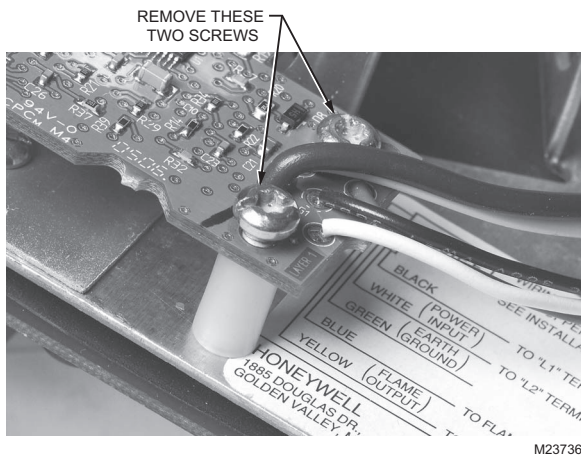

Fig. 2. Unscrewing the circuit board.

3. Locate the circuit board retaining nut and loosen it. After the nut has been loosened, loosen the third circuit board screw. See Fig. 3.

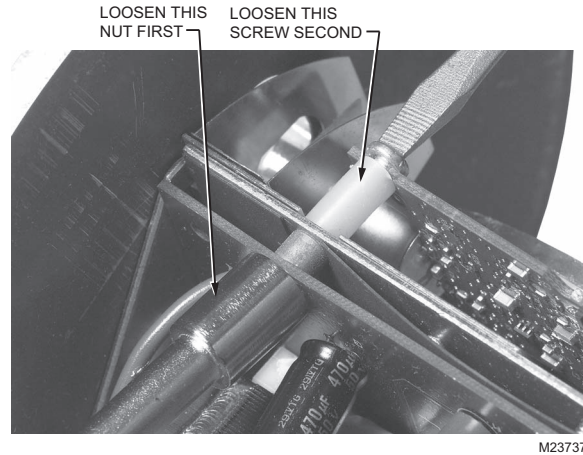

Fig. 3. Loosening the circuit board.

4. Remove the circuit board from the slot of the shutter, push it out of the way, and remove the three chopper assembly retaining screws identified in Fig. 4.

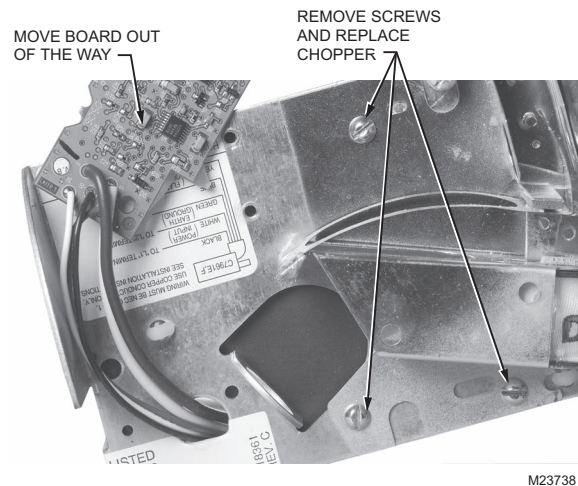
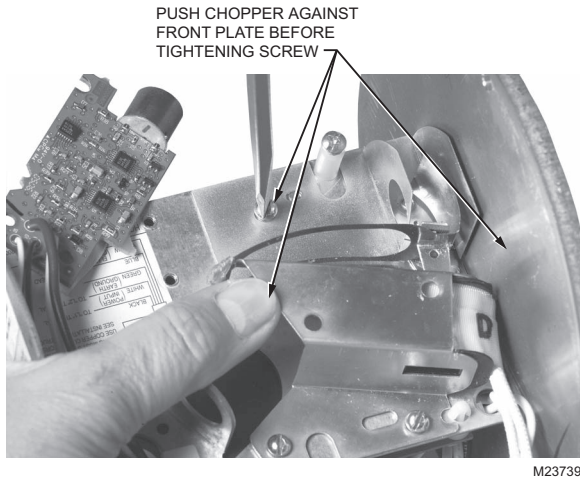

Fig. 4. Removing the chopper assembly retaining screws.

5. Install the new chopper. Push the chopper against the front plate before tightening the three screws loosened in step 4.



**Fig. 5. Inserting the circuit board.**

6. Slide the circuit board into the oval slot of the new shutter, then slide the circuit board slot underneath the screw as shown in Fig. 6.

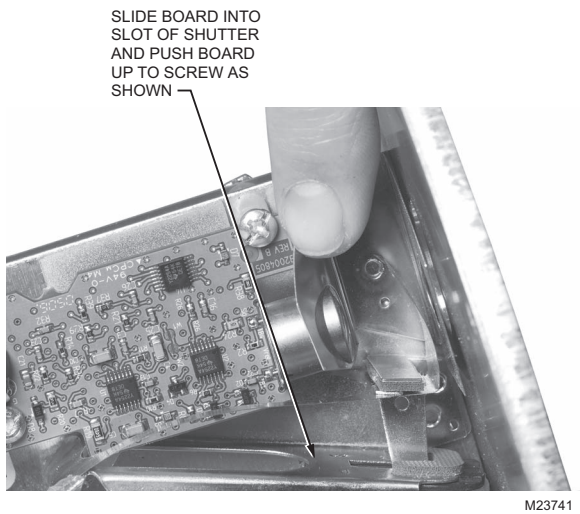

**Fig. 6. Inserting the circuit board.**

7. Move the chopper frame as shown in Fig. 7 to capture the circuit board sensor eye inside the viewing hole before replacing and tightening the screws holding the circuit board in place.

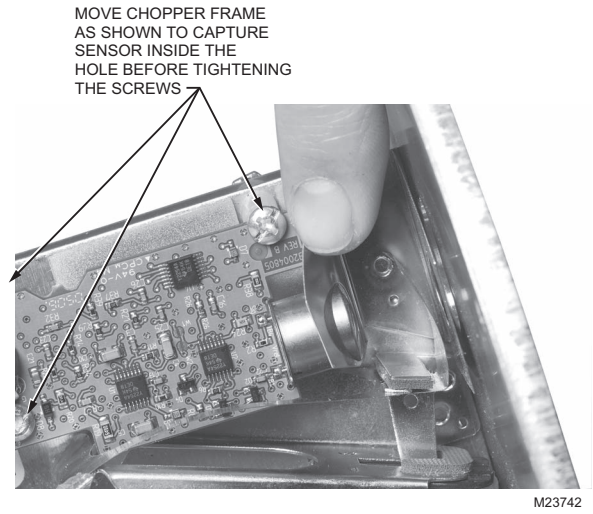

**Fig. 7. Capture circuit board sensor eye in viewing hole.**

8. Tighten the circuit board retaining nut only after the three circuit board screws have been tightened.



**Fig. 8. Tighten circuit board retaining nut.**

9. Replace the detector cover using the 4 screws set aside in step 1.

Further Information	Product Data
• C7961	65-0267
• C7024	65-0156
• Download from: <a href="http://customer.honeywell.com">http://customer.honeywell.com</a>	

**Automation and Control Solutions**

Honeywell International Inc.  
1985 Douglas Drive North  
Golden Valley, MN 55422  
customer.honeywell.com

Honeywell Limited-Honeywell Limitée  
35 Dynamic Drive  
Toronto, Ontario M1V 4Z9

© U.S. Registered Trademark  
© 2007 Honeywell International Inc.  
66-1169 M.S. 01-07



Printed in U.S.A. on recycled  
paper containing at least 10%  
post-consumer paper fibers.

**Honeywell**